







↗ Eta Wash LED 100



IP65

CE, RoHS

-  IP65
-  100 ÷ 277Vac
-  100W
-  Cree SMD LED
- 
-  Cavo L.1m
-  Corpo Nero
-  Alluminio+vetro temp.
-  -35°C
+55°C
-  50000 ore (L80B20)



CRI
≥ 80

LED
150 lm/W

GRUPPO 0
RISCHIO
FOTOBIOLOGICO

 Questo dispositivo è
munito di lampade
a LED integrate

A++ }
A+ } LED
A }

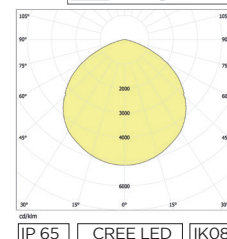

Eta Wash 100

Proiettore LED ottica wash 110° cut-off per interni ed esterni. Corpo in alluminio pressofuso verniciato con polvere termoindurente di colore nero, vetro temperato trasparente spessore 5 mm, guarnizione in silicone, molle inox che garantiscono la tenuta, valvola anti condensa, forcella di fissaggio regolabile che permette qualsiasi tipo d'installazione, alimentatore elettronico 230V incluso. Standard applicati: CE / ROHS / IEC / LM80.

Codice	Input Volt	Temperatura Colore	Watt	PFC	Lumen (TC=25°)	Lumen	CRI	LED Chip	Apertura Fascio	Materiale Frontale	Classe Isolamento	IP	IK
AR97100-WW	100-277Vac	3000K	100W	90	14000 lm	11000 lm	Ra>80	SMD LED	110°	Vetro Temp.	I	IP65	08
AR97100-NW	100-277Vac	4000K	100W	90	15000 lm	12000 lm	Ra>80	SMD LED	110°	Vetro Temp.	I	IP65	08

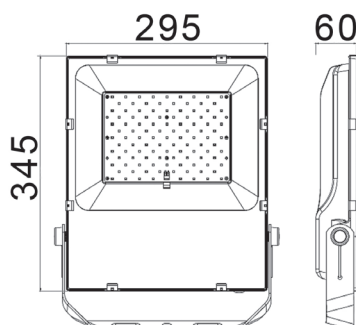

Arena Luci s.r.l. si riserva la facoltà di modificare le caratteristiche dei prodotti senza obbligo di preavviso
Arena Luci s.r.l. reserve the right to change products specifications at anytime without prior notice